

MVSA-260 series

SOLENOID VALVE

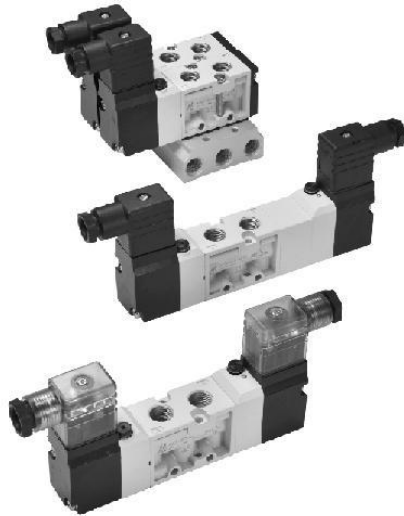

Specification

Model	4E1	4E2	4E2C.P.R
Bore No.	8A		
Port size	Rc1/4		
No. of port	5		
No. of position	2	3	
Medium	Air		
Operating pressure range	0.2~0.7 MPa	0.3~0.7 MPa	
Proof pressure	1 MPa		
Effective orifice	18 mm ²	16 mm ²	
Response time	40 ms		
Ambient temperature	- 5~ + 50℃ (No freezing)		
Voltage	AC110V, 220V (50/60)Hz, DC24V		
Power consumption	AC=3.5VA, DC=3.5W		
Available voltage range	±10%		
Insulation class	B class		
Weight	308 g	475 g	592 g

Order example of valve

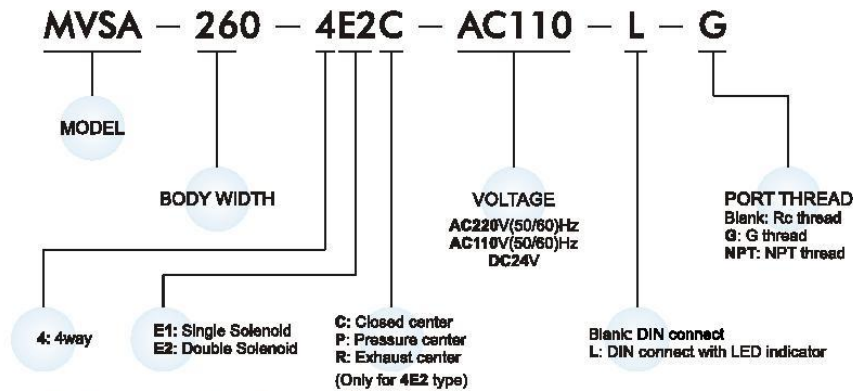

Order example of manifold

